

Linear

TANA R207

Fixture Guide

KKDÖ



Indoor | Surface | Dynamic output up to 1221lm/m (372lm/ft)



Key applications

- ✓ Architectural detail
- ✓ Cabinet & furniture
- ✓ Direct lighting
- ✓ Display case
- ✓ Interior
- ✓ Retail display
- ✓ Shelving display
- ✓ Special effect

Key features

- ✓ Custom lengths
- ✓ Constant Voltage (CV)
- ✓ Continuous light runs
- ✓ Diffusion: homogenous
- ✓ IP40 dry area
- ✓ RGB

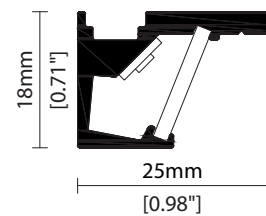

FIXING METHODS



SF Screw fixing

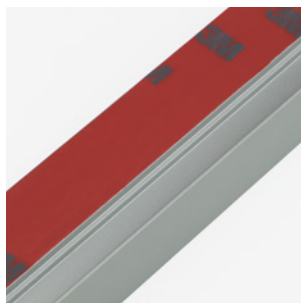

TF 3M tape fixing

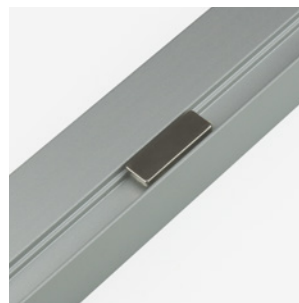

MF Magnet fixing

Warm-dim

Output Luminance %

min DIM1 Input Level max

— CH1 (Warmer)
— CH2 (Cooler)

LEDmix R207

CCT Selection 1 CCT Selection 2

LEDmix R209

CCT Selection 1 CCT Selection 2

LEDmix **warm dim** (Dynamic white) is a pre-programmed dimming curve setting enabling two different colour temperatures (CCTs) to blend harmoniously to achieve a warming lighting effect when dimmed.

KKDC LEDmix strips allow two separate CCT selections to be specified within the same PCB strip.

Use the table opposite to help determine which 2 CCT selections you require according to your preferred cool to warm dimming range.

**Note: The blended CCT is approx. 'cool-end' result at 100% brightness based on using the KKDC LED CCT specification.*

CCT Selection 1	CCT Selection 2	
	Blended CCT*	PCB CCT
1900K~	2000K 2100K 2200K 2300K 2500K 2600K 2700K 3000K 3500K	2100K PCB 2300K PCB 2500K PCB 2700K PCB 3000K PCB 3200K PCB 3500K PCB 4000K PCB 5000K PCB
2100K~	2200K 2300K 2400K 2600K 2700K 2800K 3000K 3600K	2300K PCB 2500K PCB 2700K PCB 3000K PCB 3200K PCB 3500K PCB 4000K PCB 5000K PCB
2300K~	2400K 2500K 2700K 2800K 2900K 3100K 3700K	2500K PCB 2700K PCB 3000K PCB 3200K PCB 3500K PCB 4000K PCB 5000K PCB
2500K~	2600K 2800K 2800K 3000K 3200K 3800K	2700K PCB 3000K PCB 3200K PCB 3500K PCB 4000K PCB 5000K PCB
2700K~	2900K 3000K 3100K 3400K 3900K	3000K PCB 3200K PCB 3500K PCB 4000K PCB 5000K PCB
3000K~	3100K 3300K 3500K 4000K	3200K PCB 3500K PCB 4000K PCB 5000K PCB
3200K~	3300K 3600K 4100K	3500K PCB 4000K PCB 5000K PCB
3500K~	3700K 4300K	4000K PCB 5000K PCB
4000K~	5100K	5000K PCB

Tuneable white

Channel Mix Ratio %

min DIM1 Input Level max

— CH1 (Warmer)
— CH2 (Cooler)

LEDmix R207

CCT Selection 1 CCT Selection 2

LEDmix R209

CCT Selection 1 CCT Selection 2

LEDmix **tunable white** enables two different LED colour temperatures (CCTs) to be specified within the same LEDmix strip.

Each CCT selection can then be independently controlled (via your dimming control system) to adjust the warm & cool light output (CCT selections) and thus tailor a blended light colour of your choosing.

CCT Selection 1	CCT Selection 2
1900K~	2100K 2300K 2500K 2700K 3000K 3200K 3500K 4000K 5000K
2100K~	2300K 2500K 2700K 3000K 3200K 3500K 4000K 5000K
2300K~	2500K 2700K 3000K 3200K 3500K 4000K 5000K
2500K~	2700K 3000K 3200K 3500K 4000K 5000K
2700K~	3000K 3200K 3500K 4000K 5000K
3000K~	3200K 3500K 4000K 5000K
3200K~	3500K 4000K 5000K
3500K~	4000K 5000K
4000K~	5000K

Linear

TANA R207

Specification sheet



Dimensions	H18/W25/L103-2020mm (H0.71/W0.98/L4.05-79.53in)
PCB Cut-point	83.3mm increment/2000mm max (3.28in increment/78.74in max)
LED Pitch	13.9mm-144LED/m (0.55in - 44LED/ft)
Chip	s-line k-line
Cover/Optics	Diffused (110°)/Clear @ 45 degree position (90°)/Clear @ 5 degree position (50°)
CCT	s-line: 1900K/2100K/2300K/2500K/2700K/3000K/3500K/4000K/5000K k-line: 1900K/2100K/2300K/2500K/2700K/3000K/3500K/4000K/5000K
LED binning	s-line: 2.5-step MacAdam ellipse k-line: 3-step MacAdam ellipse
CRI	≥95
Lifetime	50,000 hours @ 25°C (50,000 hours @ 77°F)
Operating temp	T _a = -25 to 50°C (T _c max = 67°C) T _a = -13 to 140°F (T _c max = 153°F)
IP Rating	IP40
Finish	Silver anodised
Mounting	Surface mounting via screw fixing, 3M tape or magnets
Power feed	Hardwire tails or male/female connectors
Control	0-10V/1-10V/DMX/DALI



LED Grading Key

Exclusive Grade

s s-line*	*KKDC tuned CCT range
2-step CCT range	

Base Grade

k k-line	3-step commercial range Energy Star CCTs
------------------------	---

Power consumption	Supply voltage	Supply current
16W/m (4.88W/ft)	24V DC	0.67A/m (0.20A/ft)

Performance Data (2100K+5000K)

	R1	R2	R3	R4	R5	R6	R7	R8	R9	R10	R11	R12	R13	R14	
k-line	96	95	97	98	96	92	94	95	93	93	96	78	95	99	
	Clear Cover											CRI	R9	Rf	Rg
s-line	1221lm/m (372lm/ft) 76.3lm/W											96	94	-	-
k-line	1152lm/m (351lm/ft) 72lm/W											95	93	-	-
	Diffused Cover														
s-line	882lm/m (269lm/ft) 55.1lm/W														
k-line	832lm/m (254lm/ft) 52lm/W														

Hardwire Tails

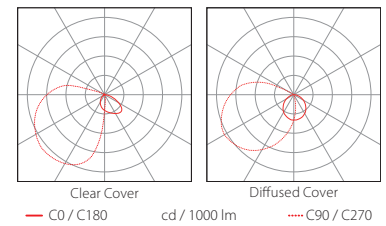
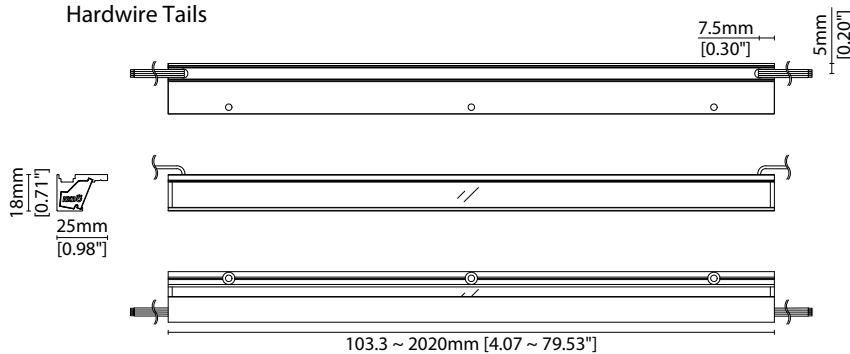

Data derived from independent UKAS / IESNA LM-79-08 accredited testing of production samples.

FIXTURE

Model	Finish	Cover ¹	Grade ²	LED	Colour	Length Availability ³	IP	Cable Length	Power Feed ⁴	Fixing ⁵	LED Position	Input
TANA TN	Silver Anodised SA	Clear B Diffused C	s s ⁶ k e ⁶	R207 R207	1900K 19 2100K 21 2300K 23 2500K 25 2700K 27 3000K 30 3500K 35 4000K 40 5000K 50	m 103.3-2020mm 83.3mm increments i 4.07-79.53in 3.28in increments (Specify length code OR total run length)	IP40 40	50mm/ 1.97" 0050 1000mm/ 39.37" 1000 3000mm/ 118.11" 3000	Single no sheath tail S00X Double no sheath tail D00X Single no sheath IP20 connector S20X Double no sheath IP20 connector D20X	Screw SF 3M Tape TF Magnet MF	45° 45	DC g 24V

¹ Refer to **Cover Options** on **Options** pages

² Refer to **LED Grading Key** on **Specification sheet** page

³ Refer to **Length Availability List** or enter total run length instead of length code

⁴ Refer to **Power Feed Options** on **Options** pages

⁵ Refer to **Fixing Options** on **Options** Pages

⁶ LEDmix requires two colour temperature choices

Code Example:

TN	-	SA	-	C	-	s	-	R207	-	2150	-	m	-	520	-	40	-	1000	-	D00X	-	SF	-	45	-	g
TANA		Silver Anodised		Diffused				R207		2100K+5000K		520mm		IP40		1000mm/39.37"		Double no sheath tail		Screw		45°		DC	24V	

ACCESSORIES

Connection Accessories

KKCN-18	4 PIN LEDmix male & female 50mm (1.97in) pair
KKCN-19	4 PIN LEDmix male & female 300mm (11.81in) pair
KKCN-24	4 PIN LEDmix 300mm (11.81in) extension lead

PSU/Driver

0-10V/1-10V/DALI/DMX

* Refer to **Driver/PSU Options** page for details or provide requirement and KKDC to offer the suitable option

* Refer to **Power feed** on **Accessories** pages

LED ENGINE VARIANTS (LED STRIP TYPE)

Colour	LED	Lumen/m	Lumen/ft	W/m	W/ft	Spec Doc	Length	Increment
Single CCT	R007	534	163	7	2.13	TANA R007	103-2020mm (4.05-79.53in)	41.7mm (1.64in)
	R014	1098	335	14	4.27	TANA R014	103-2020mm (4.05-79.53in)	41.7mm (1.64in)
	R020	1569	478	20	6.10	TANA R020	103-2020mm (4.05-79.53in)	41.7mm (1.64in)
	2 R014	1751	534	28	8.53	TANA 2 R014	103-2020mm (4.05-79.53in)	41.7mm (1.64in)
Warm Dim/Dynamic White	R207	1221	372	16	4.88	TANA R207	103-2020mm (4.05-79.53in)	83.3mm (3.28in)
RGB	501	Red: 119 Green: 257 Blue: 42 RGB: 372	Red: 36 Green: 78 Blue: 13 RGB: 113	15.6	4.75	TANA RGB	103-2020mm (4.05-79.53in)	83.3mm (3.28in)

* Performance data: s-line, 2100K + 5000K, diffused cover

TANA R207

Length Availability List

Length Code		Fixture Length ¹		LED Strip ²		End Cap Dimension ³		Wattage (W)	Output (lm)
Metric	Imperial(US)	Metric	Imperial(US)	Metric	Imperial(US)	Metric	Imperial(US)		3000K (Test Data)
m0103	i0004	103mm	4.07in	83mm	3.28in	0mm	0.00in	1.33	43
m0187	i0006	187mm	7.35in	167mm	6.56in	0mm	0.00in	2.67	85
m0270	i0007	270mm	10.63in	250mm	9.84in	0mm	0.00in	4.00	128
m0353	i0009	353mm	13.91in	333mm	13.12in	0mm	0.00in	5.33	171
m0437	i0011	437mm	17.19in	417mm	16.40in	0mm	0.00in	6.67	213
m0520	i0012	520mm	20.47in	500mm	19.69in	0mm	0.00in	8.00	256
m0603	i0014	603mm	23.75in	583mm	22.97in	0mm	0.00in	9.33	299
m0687	i0016	687mm	27.03in	667mm	26.25in	0mm	0.00in	10.67	341
m0770	i0017	770mm	30.31in	750mm	29.53in	0mm	0.00in	12.00	384
m0853	i0019	853mm	33.60in	833mm	32.81in	0mm	0.00in	13.33	427
m0937	i0020	937mm	36.88in	917mm	36.09in	0mm	0.00in	14.67	469
m1020	i0022	1020mm	40.16in	1000mm	39.37in	0mm	0.00in	16.00	512
m1103	i0024	1103mm	43.44in	1083mm	42.65in	0mm	0.00in	17.33	555
m1187	i0025	1187mm	46.72in	1167mm	45.93in	0mm	0.00in	18.67	597
m1270	i0027	1270mm	50.00in	1250mm	49.21in	0mm	0.00in	20.00	640
m1353	i0029	1353mm	53.28in	1333mm	52.49in	0mm	0.00in	21.33	683
m1437	i0030	1437mm	56.56in	1417mm	55.77in	0mm	0.00in	22.67	725
m1520	i0032	1520mm	59.84in	1500mm	59.06in	0mm	0.00in	24.00	768
m1603	i0063	1603mm	63.12in	1583mm	62.34in	0mm	0.00in	25.33	811
m1687	i0066	1687mm	66.40in	1667mm	65.62in	0mm	0.00in	26.67	853
m1770	i0070	1770mm	69.69in	1750mm	68.90in	0mm	0.00in	28.00	896
m1853	i0073	1853mm	72.97in	1833mm	72.18in	0mm	0.00in	29.33	939
m1937	i0076	1937mm	76.25in	1917mm	75.46in	0mm	0.00in	30.67	981
m2020	i0079	2020mm	79.53in	2000mm	78.74in	0mm	0.00in	32.00	1024

¹ Actual total overall length of light fixture (LED strip + end caps + void/wire hole)

² Actual length of PCB strip

³ Actual length of 2x end caps

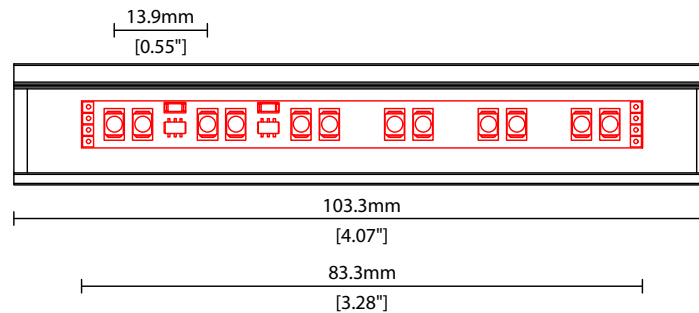

LED POSITION OPTION

* Options are an integral part of the fixture ordering codes. Please refer to **Code Table** pages.

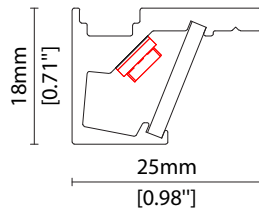
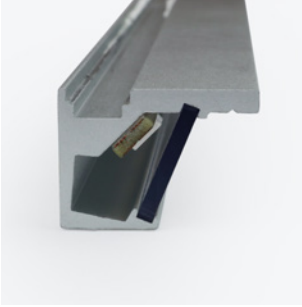

45 45° LED position

COVER OPTIONS

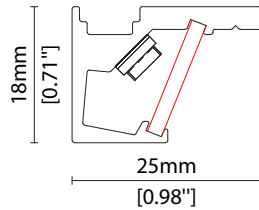

B Clear cover
Polycarbonate

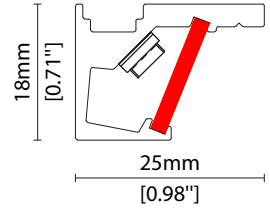

C Diffused cover
Polycarbonate

FIXING OPTIONS

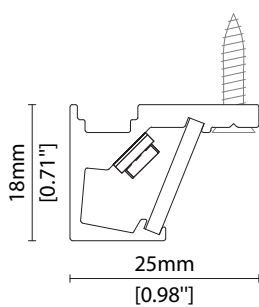

SF Screw fixing

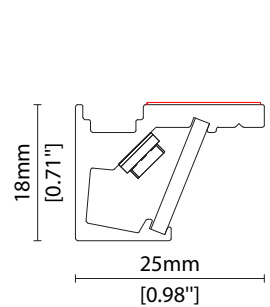
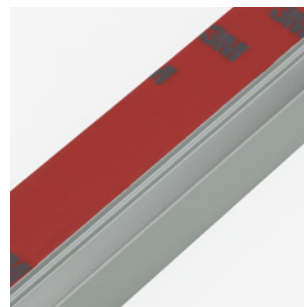

TF 3M tape fixing

FIXING OPTIONS (CONTINUED)

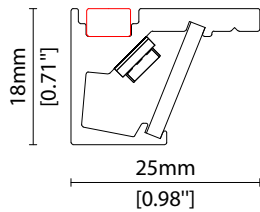

MF Magnet fixing

POWER FEED OPTIONS

0050 S20X 50mm (1.97") Single IP20 connector

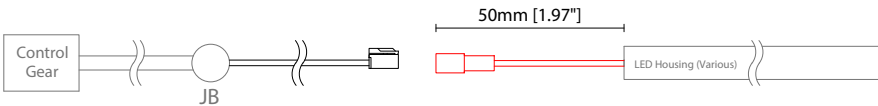

0050 D20X 50mm (1.97") Double IP20 connector

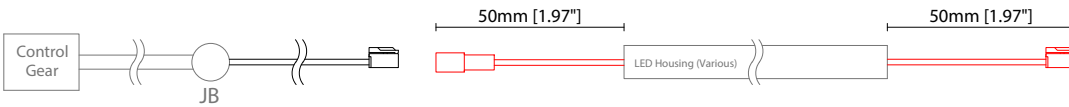

1000 S00X 1000mm (39.37") Single tail

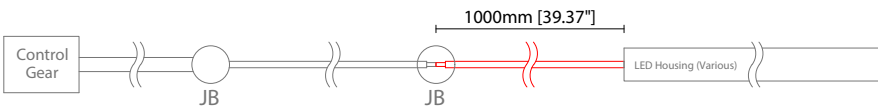

1000 D00X 1000mm (39.37") Double tail

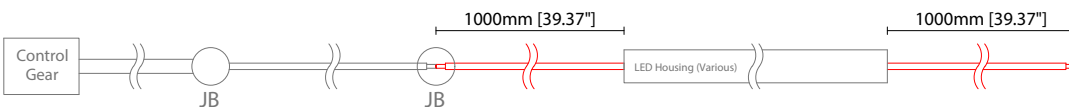

1000 S20X 1000mm (39.37") Single IP20 connector

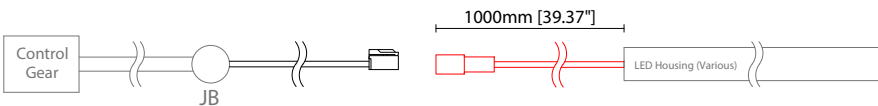

1000 D20X 1000mm (39.37") Double IP20 connector

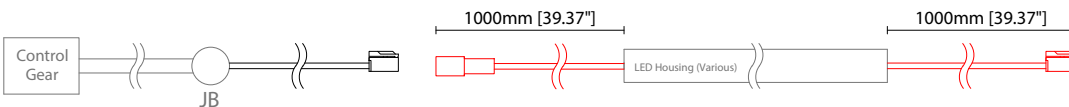

Key

Control Gear Power supply, sub-controllers & control systems

JB Junction box / cable connection

POWER FEED OPTIONS (CONTINUED)

3000 S00X 3000mm (118.11") Single tail

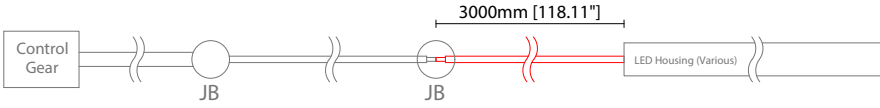

3000 D00X 3000mm (118.11") Double tail

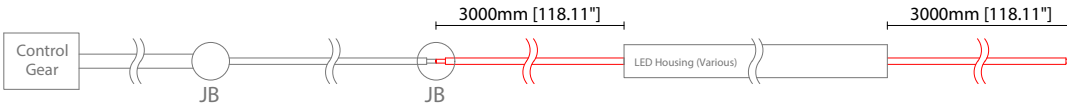

3000 S20X 3000mm (118.11") Single IP20 connector

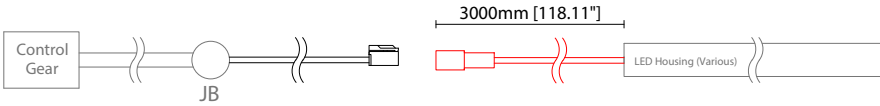

3000 D20X 3000mm (118.11") Double IP20 connector

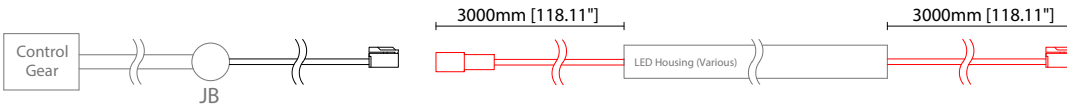

4 Pin LEDmix Female Connector

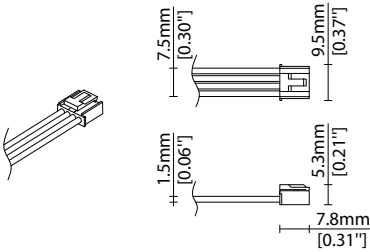

4 Pin LEDmix Male Connector

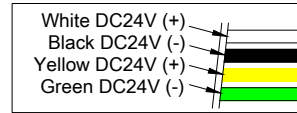
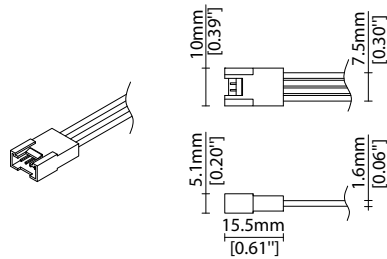

Key

- Control Gear Power supply, sub-controllers & control systems
- JB Junction box / cable connection

POWER FEED

Note: Accessories are to be ordered separately with corresponding code shown below.

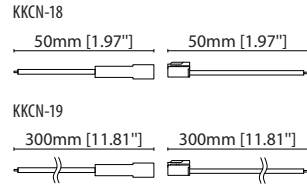
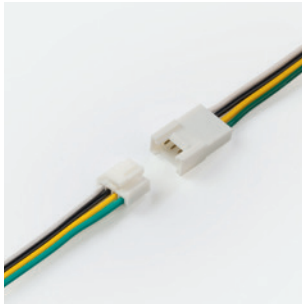

KKCN-18 50mm (1.97in) pair
KKCN-19 300mm (11.81in) pair
 4 PIN LEDmix male + female
 connector set

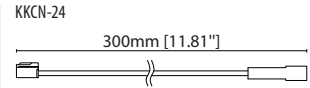

KKCN-24
 4 PIN LEDmix 300mm (11.81in)
 extension lead

KKDC CONTROL



IP20
Plastic housing
L170/W59/H29mm
(L6.69/W2.32/H1.14in)

KKDM-06 1-10V
visDIM dimmable sub-controller
(4 x 8A max @ 12-36V)



IP20
Plastic housing
L170/W53.4/H28mm
(L6.69/W2.10/H1.10in)

KKSC-05 DMX
visDIM dimmable sub-controller
(4 x 5A max @ 12-36V)



IP20
Plastic housing
L170/W59/H29mm
(L6.69/W2.32/H1.14in)

KKDL-02 DALI
visDIM dimmable sub-controller
(4 x 8A max @ 12-36V)



IP20
Plastic housing
L166/W53.4/H23mm
(L6.54/W2.10/H0.91in)

KKDL-03 DALI
visDIM dimmable sub-controller
(4 x 5A max @ 12-36V)



IP20
Plastic housing
L170/W53.4/H28mm
(L6.69/W2.10/H1.10in)

KKDL-04 DALI-2
visDIM dimmable sub-controller
(4 x 5A max @ 12-36V)

AVAILABLE PSU OPTIONS

Control Mode	PSU (Order Code)	Input Voltage AC	Output Voltage DC	Rated Output Current	Rated Power	Dim %	IP Rating
Switched	CEN-60-24	90-295V	24V	2.5A	60W	-	IP67
	HLG-60H-24	90-305V	24V	2.5A	60W	-	IP67
	HLG-100H-24	90-305V	24V	4.0A	100W	-	IP67
	HLG-150H-24	90-305V	24V	6.3A	150W	-	IP67
	HLG-240H-24	90-305V	24V	10A	240W	-	IP67
0-10V (1-10V)	PWM-40-24	90-305V	24V	1.67A	40W	100-0.15 (100-10)	IP67
	PWM-60-24	90-305V	24V	2.5A	60W	100-0.15 (100-10)	IP67
	PWM-90-24	90-305V	24V	3.67A	90W	100-0.15 (100-10)	IP67
	PWM-120-24	90-305V	24V	5.0A	120W	100-0.15 (100-10)	IP67
DALI	LIN100A1	120-277V	24V	1A per channel	100W	100-0.1	IP66/IP40
DMX RGB	LIN100A1	120-277V	24V	1.33A per channel	100W	100-0.1	IP66/IP40
DMX RGBW	LIN100A1	120-277A	24V	1A per channel	100W	100-0.1	IP66/IP40

Flicker Free Options - Combination of PSU+ sub-controller

Control Mode	PSU (Order Code)	Sub-controller (Order Code)	Input Voltage AC	Output Voltage DC	Rated Output Current	Rated Power	Dim %	IP Rating PSU/ Sub-controller
0-10V or 1-10V	CEN-60-24	KKDM-06	90-295V	24V	2.5A	60W	100-0.9	IP67/IP20
	HLG-60H-24	KKDM-06	90-295V	24V	2.5A	60W	100-0.9	IP67/IP20
	HLG-100H-24	KKDM-06	90-295V	24V	4.0A	100W	100-0.9	IP67/IP20
	HLG-150H-24	KKDM-06	90-295V	24V	6.3A	150W	100-0.9	IP67/IP20
	HLG-240H-24	KKDM-06	90-295V	24V	10.0A	240W	100-0.9	IP67/IP20
DALI	CEN-60-24	KKDL-02/03/04/visDIM PRO 30	90-295V	24V	2.5A	60W	100-0.1	IP67/IP20
	HLG-60H-24	KKDL-02/03/04/visDIM PRO 30	90-305V	24V	2.5A	60W	100-0.1	IP67/IP20
	HLG-100H-24	KKDL-02/03/04/visDIM PRO 30	90-305V	24V	4.0A	100W	100-0.1	IP67/IP20
	HLG-150H-24	KKDL-02/03/04/visDIM PRO 30	90-305V	24V	6.3A	150W	100-0.1	IP67/IP20
	HLG-240H-24	KKDL-02/03/04/visDIM PRO 30	90-305V	24V	10.0A	240W	100-0.1	IP67/IP20
DMX RGB	CEN-60-24	KKSC-05	90-295V	24V	2.5A	60W	100-0.9	IP67/IP20
	HLG-60H-24	KKSC-05	90-305V	24V	2.5A	60W	100-0.9	IP67/IP20
	HLG-100H-24	KKSC-05	90-305V	24V	4A	100W	100-0.9	IP67/IP20
	HLG-150H-24	KKSC-05	90-305V	24V	6.3A	150W	100-0.9	IP67/IP20
	HLG-240H-24	KKSC-05	90-305V	24V	10.0A	240W	100-0.9	IP67/IP20

¹ The items shown above cover the most frequently used specification but does not exhaust the possible options

² PSU and/or driver can be chosen from the table, or KKDC may recommend the best option upon receipt of the controls requirement and installation environment

³ Electrical shop drawing will include detailed information of PSU and relevant control drivers

⁴ Cut sheets are available on the controls section of www.kkdc.lighting or upon request